

# 6010 K

## Ceramic hob

### Installation and Operating Instructions

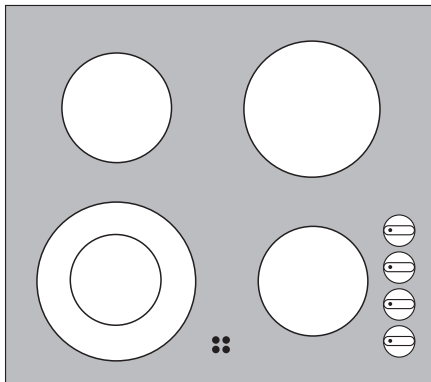

## Dear Customer,

Please read these user instructions carefully and keep them to refer to later.

Please pass the user instructions on to any future owner of the appliance.

### The following symbols are used in the text:



Safety instructions

**Warning!** Notes that concern your personal safety.

**Important!** Notes that show how to avoid damage to the appliance.



Useful tips and hints



Environmental information

# Contents

<b>Operating Instructions</b> .....	4
<b>Safety instructions</b> .....	4
<b>Description of the Appliance</b> .....	6
Cooking surface layout.....	6
Assignment of control knobs.....	6
Control Knobs.....	7
Residual heat indicator.....	7
<b>Operating the appliance</b> .....	7
Selecting the heat setting.....	8
To switch the outside ring on and off.....	8
<b>Tips on cooking and frying</b> .....	9
Cookware.....	9
Energy saving.....	9
Examples of cooking applications.....	10
<b>Cleaning and care</b> .....	11
<b>What to do if ...</b> .....	12
<b>Disposal</b> .....	12
<b>Installation Instructions</b> .....	13
Electrical Connection Diagram.....	14
<b>Assembly</b> .....	15
Rating Plates.....	17
<b>Warranty conditions</b> .....	18
<b>Service and Spare Parts</b> .....	19

# Operating Instructions



## Safety instructions



Please comply with these instructions. If you do not, any damage resulting is not covered by the warranty.



This appliance conforms with the following EU Directives:

- 73/23/EEC dated 19.02.1973 Low Voltage Directive
- 89/336/EEC dated 03.05.1989 EMC Directive inclusive of Amending Directive 92/31/EEC
- 93/68/EEC dated 22.07.1993 CE Marking Directive

## Correct use

- This appliance should be used only for normal domestic cooking and frying of food.
- The appliance must not be used as a work surface or as a storage surface.
- Additions or modifications to the appliance are not permitted.
- Do not place or store flammable liquids, highly inflammable materials or fusible objects (e.g. plastic film, plastic, aluminium) on or near the appliance.

## Child safety

- Small children must be kept away from the appliance.
- Only let bigger children work on the appliance under supervision.

## General safety

- The appliance may only be installed and connected by trained, registered service engineers, or competent persons.
- Built-in appliances may only be used after they have been built in to suitable built-in units and work surfaces that meet standards.
- In the event of faults with the appliance or damage to the glass ceramic (cracks, scratches or splits), the appliance must be switched off and disconnected from the electrical supply to prevent the possibility of an electric shock.
- Repairs to the appliance must only be carried out by trained registered service engineers.

---

## **Safety during use**

- Remove stickers and film from the glass ceramic.
- There is the risk of burns from the appliance if used carelessly.
- Cables from electrical appliances must not touch the hot surface of the appliance or hot cookware.
- Overheated fat and oil can ignite quickly. When cooking with fat or oil (e.g. frying chips) do not leave the appliance unattended.
- Switch the cooking zones off after each use.

## **Safety when cleaning**

- For cleaning, the appliance must be switched off and cooled down.
- For safety reasons, the cleaning of the appliance with steam jet or high-pressure cleaning equipment is not permitted.

## **How to avoid damage to the appliance**

- The ceramic glass can be damaged by objects falling onto it.
- The edge of the ceramic glass can be damaged by being knocked by the cookware.
- Cookware made of cast iron, cast aluminium or with damaged bottoms can scratch the ceramic glass if pushed across the surface.
- Objects that melt and things that boil over can burn onto the ceramic glass and should be removed straightaway.
- Do not use the cooking zones with empty cookware or without cookware.

# Description of the Appliance

## Cooking surface layout

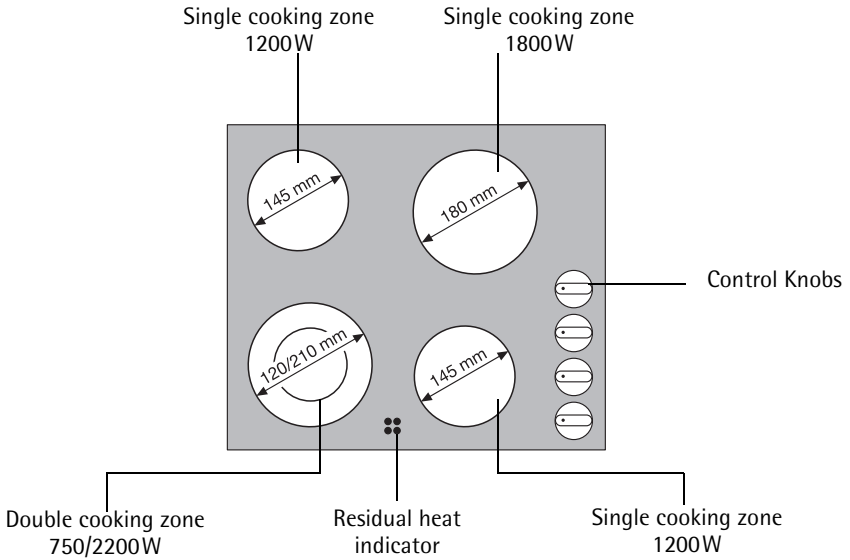

## Assignment of control knobs

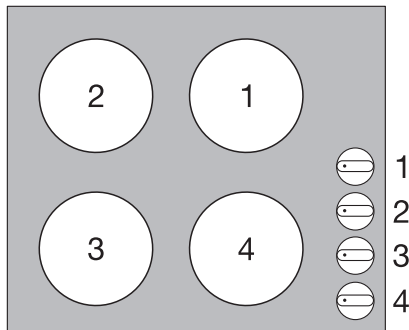

## Control Knobs

The cooking power can be set anywhere between level 1 and 9.

1	lowest power
9	highest power
0	Off position
	Connection double ring cooking zone

## Residual heat indicator

The residual heat indicator lights up, as soon as the corresponding cooking zone is hot.



**Danger!** Risk of burns from residual heat. After being switched off, the cooking zones need some time to cool down. Look at the residual heat indicator.





Residual heat can be used for melting and keeping food warm.

## Operating the appliance



When a cooking zone is switched on, it may hum briefly. This is a characteristic of all ceramic glass cooking zones and does not impair either the function or the life of the appliance.

## Selecting the heat setting

Heat setting	Ring control knob	Knob setting
To increase	turn clockwise 	1 - 9
To reduce	turn anti-clockwise 	9 - 1
switch off	0	



1. When boiling water/searing food, select a high heat setting.
2. As soon as steam forms or the fat or oil is hot, set a lower heat setting.
3. To end the cooking process, turn to the Off position.

## To switch the outside ring on and off

By switching the outside ring on or off, the effective heating surface can be matched to the size of the cookware.



Before the outside ring can be switched on, the inside ring must be switched on.

Outside ring	Ring switch	Switch setting
To switch on	Turn clockwise, past a slight resistance, as far as it will go 	
	Turn anti-clockwise to the desired heat setting	1 - 9
To switch off	Turn to the Off position	0



# Tips on cooking and frying



## Information about acrylamides

According to the latest scientific research, intensive browning of food, especially in products containing starch, may present a health risk due to acrylamide. Therefore we recommend cooking at low temperatures and not browning foods too much.

## Cookware

- You can recognise good cookware from the bottoms of the pans. The bottom should be as thick and flat as possible.
- Cookware made of enamelled steel or with aluminium or copper bottoms can leave discolourations on the ceramic glass surface which are difficult or impossible to remove.

## Energy saving



Always place cookware on the cooking zone before it is switched on.



If possible, always place lids on the pans.

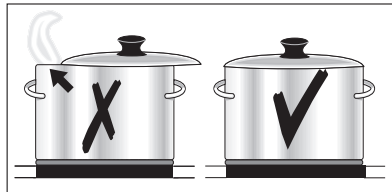

Switch cooking zones off before the end of the cooking time, to take advantage of residual heat.



Bottom of pans and cooking zones should be the same size.

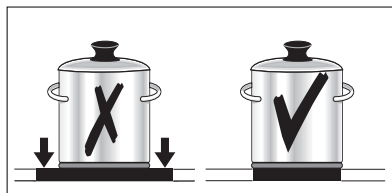

## Examples of cooking applications

The information given in the following table is for guidance only.

Heat setting	Cooking process	suitable for	Cook time	Tips/Hints
0		Nachwärme, Off position		
1	<b>Keeping food warm</b>	Keeping cooked foods warm	as required	Cover
1-2	<b>Melting</b>	Hollandaise sauce, melting butter, chocolate, gelatine	5-25 mins.	Stir occasionally
	<b>Solidifying</b>	Fluffy omelettes, baked eggs	10-40 mins.	Cook with lid on
2-3	<b>Simmering</b>	Simmering rice and milk-based dishes Heating up ready-cooked meals	25-50 mins.	Add at least twice as much liquid as rice, stir milk dishes part way through cooking
3-4	<b>Steaming Braising</b>	Steaming vegetables, fish Braising meat	20-45 mins.	With vegetables add only a little liquid (a few tablespoons)
4-5	<b>Boiling</b>	Steaming potatoes	20-60 mins.	Use only a little liquid, e. g.: max. 1/4 l water for 750 g of potatoes
		Cooking larger quantities of food, stews and soups	60-150 mins.	Up to 3 l liquid plus ingredients
6-7	<b>Gentle frying</b>	Frying escalope, veal cordon bleu, cutlets, rissoles, sausages, liver, roux, eggs, pancakes, doughnuts	as required	Turn halfway through cooking
7-8	<b>Heavy frying</b>	Hash browns, loin steaks, steaks, Flädle (pancakes for garnishing soup)	5-15 mins. per pan	Turn halfway through cooking
9	<b>Boiling Searing Deep frying</b>	Boiling large quantities of water, cooking pasta, searing meat (goulash, pot roast), deep frying chips		

# Cleaning and care



**Take care!** Risk of burns from residual heat.



**Important** Sharp objects and abrasive cleaning materials will damage the appliance. Clean with water and washing up liquid.



**Important** Residues from cleaning agents will damage the appliance. Remove residues with water and washing up liquid.

## Cleaning the appliance after each use

1. Wipe the appliance with a damp cloth and a little washing up liquid.
2. Rub the appliance dry using a clean cloth.

## Removing deposits

1. Place the scraper on the glass ceramic surface at an angle.
2. Remove residues by sliding the blade over the surface.
3. Wipe the appliance with a damp cloth and a little washing up liquid.
4. Rub the appliance dry using a clean cloth.

Type of dirt	Remove		
	immediately	when the appliance has cooled down	using
sugar, food containing sugar	yes	---	a scraper*
plastics, tin foil	yes	---	
limescale and water rings	---	yes	cleaner for glass ceramic or stainless steel*
fat splashes	---	yes	
shiny metallic discolorations	---	yes	

\*Scrapers and cleaners for glass ceramic and stainless steel can be purchased in specialist shops, supermarkets, the parts department of your local Service Force Centre or from [www.shop.electrolux.co.uk](http://www.shop.electrolux.co.uk)



Remove stubborn residues with a cleaner for glass ceramic or stainless steel.



Scratches or dark stains on the glass ceramic that cannot be removed do not however affect the functioning of the appliance.

# What to do if ...

Problem	Possible cause	Remedy
The cooking zones are not functioning.	The desired heat setting is not set.	Set the heat setting.
	The fuse in the house's electrical wiring (fuse box) has been tripped.	Check the fuse. If the fuses trip a number of times, please call an authorised electrician.
The residual heat indicator is not displaying anything	The cooking zone was only on for a short time and is therefore not hot	If the cooking zone is supposed to be hot, call your local Service Force Centre.

**If you are unable to remedy the problem by following the above suggestions, please contact your local Service Force Centre.**



**Warning!** Repairs to the appliance are only to be carried out by qualified service engineers. Considerable danger to the user may result from improper repairs.



If the appliance has been wrongly operated, the visit from the service technician or dealer may not take place free of charge, even during the warranty period.

## Disposal



### Packaging material

The packaging materials are environmentally friendly and can be recycled. The plastic components are identified by markings, e.g. >PE<, >PS<, etc. Please dispose of the packaging materials in the appropriate container at your local waste disposal facilities.



### Old appliance

The symbol  on the product or on its packaging indicates that this product may not be treated as household waste. Instead it shall be handed over to the applicable collection point for the recycling of electrical and electronic equipment. By ensuring this product is disposed of correctly, you will help prevent potential negative consequences for the environment and human health, which could otherwise be caused by inappropriate waste handling of this product. For more detailed information about recycling of this product, please contact your local city office, your household waste disposal service or the shop where you purchased the product.

# Installation Instructions

## Safety instructions

The laws, ordinances, directives and standards in force in the country of use are to be followed (safety regulations, proper recycling in accordance with the regulations, etc.)

Installation may only be carried out by a qualified electrician.

The minimum distances to other appliances and units are to be observed.

### **A protective floor must be installed under the appliance.**

The cut surfaces of the worktop are to be protected against moisture using a suitable sealant.

The sealant seals the appliance to the work top with no gap.

The sealant seals the appliance to the work top with no gap.

Do not use silicon sealant between the appliance and the work top.

Avoid installing the appliance next to doors and under windows. Otherwise hot cookware may be knocked off the rings when doors and windows are opened.



### **WARNING!**

Risk of injury from electrical current.

- The electrical mains terminal is live.
- Observe connection schematic.
- Observe electrical safety rules.
- Ensure anti-shock protection through correct installation by a qualified electrician.
- The appliance must be connected to the electrical supply by a qualified electrician.



### **IMPORTANT!**

Risk of injury from electrical current.

Loose and inappropriate plug and socket connections can make the terminal overheat.

- Have the clamping joints correctedly installed by a qualified electrician.
- Use strain relief clamp on cable.
- In the event of single-phase or two-phase connection, the appropriate mains cable of type H05BB-F Tmax 90° (or higher) must be used.
- If this appliance's mains cable is damaged, it must be replaced by a special cable (type H05BB-F Tmax 90°; or higher). Please contact your local Service Force Center for further advice.

A device must be provided in the electrical installation which allows the appliance to be disconnected from the mains at all poles with a contact opening width of at least 3 mm  
Suitable isolation devices include line protecting cut-outs, fuses (screw type fuses are to be removed from the holder), earth leakage trips and contactors.

## Electrical Connection Diagram

For UK only: 230V...240V~

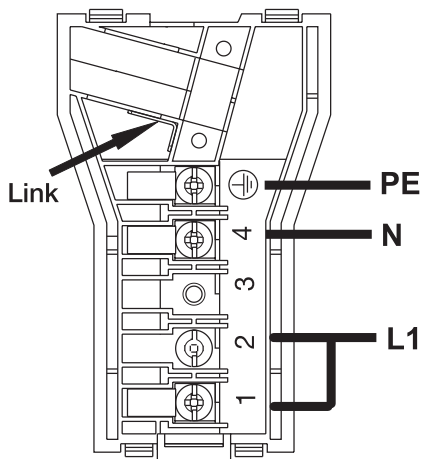



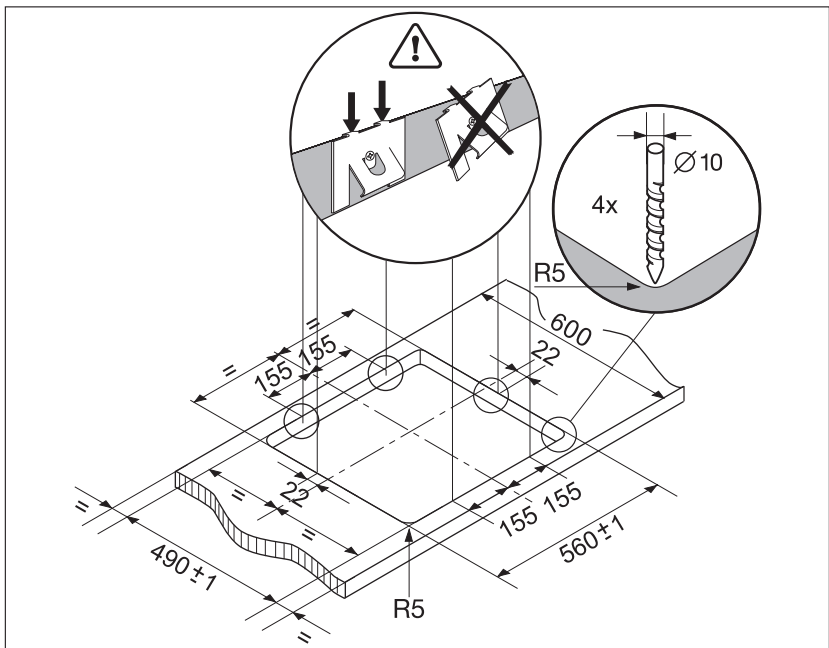
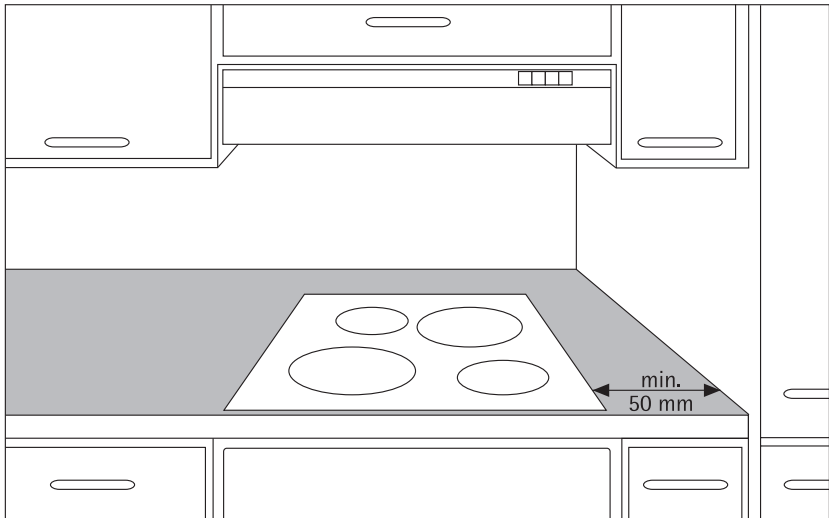

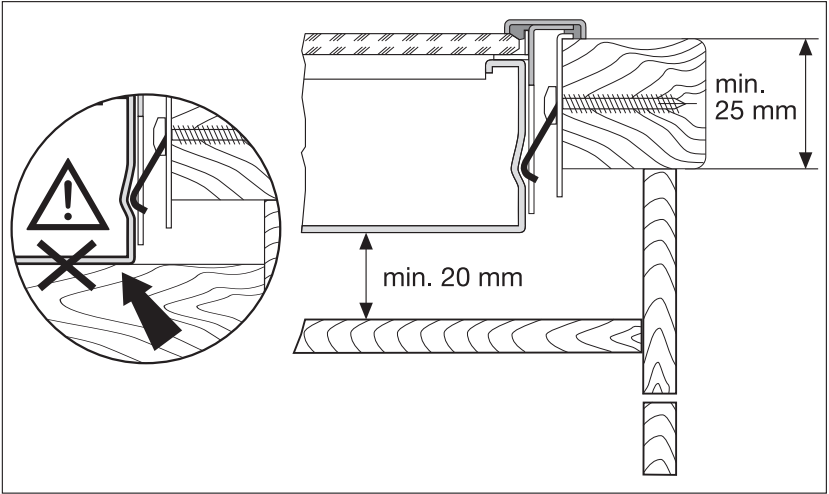
# Assembly











# Rating Plates

Modell 6010K-BN		Prod.Nr. 949 591 702	
Typ PE E20 05	230 V	50 Hz	
Made in Germany	Ser.Nr. ....	6,4 kW	
AEG-ELECTROLUX		 	

Modell 6010K-BN		Prod.Nr. 949 592 380	
Typ PE E20 05	230 V	50 Hz	
Made in Germany	Ser.Nr. ....	6,4 kW	
AEG-ELECTROLUX		 	

# Warranty conditions

## Great Britain

### Standard guarantee conditions

We, AEG, undertake that if within 12 months of the date of the purchase this AEG appliance or any part thereof is proved to be defective by reason only of faulty workmanship or materials, we will, at our discretion repair or replace the same FREE OF CHARGE for labour, materials or carriage on condition that:

- The appliance has been correctly installed and used only on the electricity or gas supply stated on the rating plate.
- The appliance has been used for normal domestic purposes only, and in accordance with the manufacturer's operating and maintenance instructions.
- The appliance has not been serviced, maintained, repaired, taken apart or tampered with by any person not authorised by us.
- All service work under this guarantee must be undertaken by a Service Force Centre. Any appliance or defective part replaced shall become the Company's property.
- This guarantee is in addition to your statutory and other legal rights.
- Home visits are made between 8.30am and 5.30pm Monday to Friday. Visits may be available outside these hours in which case a premium will be charged.

### Exclusions

This guarantee does not cover:

- Damage or calls resulting from transportation, improper use or neglect, the replacement of any light bulbs or removable parts of glass or plastic.
- Costs incurred for calls to put right an appliance which is improperly installed or calls to appliances outside the United Kingdom.
- Appliances found to be in use within a commercial environment, plus those which are subject to rental agreements.
- Products of AEG manufacture which are not marketed by AEG.

### European Guarantee

If you should move to another country within Europe then your guarantee moves with you to your new home subject to the following qualifications:

- The guarantee starts from the date you first purchased your product.
- The guarantee is for the same period and to the same extent for labour and parts as exists in the new country of use for this brand or range of products.
- This guarantee relates to you and cannot be transferred to another user.
- Your new home is within the European Community (EC) or European Free Trade Area.
- The product is installed and used in accordance with our instructions and is only used domestically, i.e. a normal household.
- The product is installed taking into account regulations in your new country.

Before you move please contact your nearest Customer Care centre, listed below, to give them details of your new home. They will then ensure that the local Service Organisation is aware of your move and able to look after you and your appliances.

France	Senlis	+33 (0) 3 44 62 29 29
Germany	Nürnberg	+49 (0) 800 234 7378
Italy	Pordenone	+39 (0) 800 117511
Sweden	Stockholm	+46 (0) 8 672 5360
UK	Luton	+44 (0) 8705 350 350

# Service and Spare Parts

If the event of your appliance requiring service, or if you wish to purchase spare parts, please contact Service Force by telephoning:

**0870 5 929 929**

Your telephone call will be automatically routed to the Service Force Centre covering your post code area.

For the address of your local Service Force Centre and further information about Service Force, please visit the website at

**www.serviceforce.co.uk**

Before calling out an engineer, please ensure you have read the details under the heading „What to do if...“

When you contact the Service Force Centre you will need to give the following details:

1. Your name, address and post code.
2. Your telephone number.
3. Clear and concise details of the fault.
4. The model and serial number of the appliance (found on the rating plate)
5. The purchase date.

Please note that a valid purchase receipt or guarantee documentation is required for in-guarantee service calls.

## Customer Care

For general enquiries concerning your AEG appliance, or for further information on AEG products please contact our Customer Care Department by letter or telephone at the address below or visit our website at **www.aeg.co.uk**.

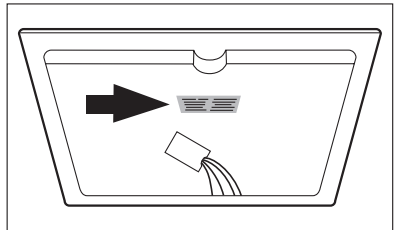

Customer Care Department  
Major Appliances  
AEG Domestic Appliances  
Addington Way  
Luton  
Bedfordshire, LU4 9QQ  
Tel: 08705 350350 (\*)

**For Customer Service in the Republic of Ireland** please contact us at the address below:

AEG/ Electrolux Group (Ire) Ltd  
Long Mile Road/ Dublin 12  
Republic of Ireland  
Tel: +353 (0) 1 4090754  
Email: service.eid@electrolux.ie

(\*) Calls may be recorded for training purposes

 **From the Electrolux Group. The world's No. 1 choice.**

*The Electrolux Group is the world's largest producer of powered appliances for kitchen, cleaning and outdoor use. More than 55 million Electrolux Group products (such as refrigerators, cookers, washing machines, vacuum cleaners, chain saws and lawn mowers) are sold each year to a value of approx. USD 14 billion in more than 150 countries around the world.*

AEG Hausgeräte GmbH  
Postfach 1036  
D-90327 Nürnberg

<http://www.aeg-electrolux.de>

© Copyright by AEG

822 925 098-B-121005-03

Subject to change without notice